

# Pacific VGA Bridge Dual Transparent

## VGA Bridge 3 Slot

This product is intended for installation only by expert users. Please consult with a qualified technician for installation. Improper installation may result in damage to your equipment.

Before you start using this product please follow these basic guidelines:

1. Please carefully read through the instruction manual before beginning the installation process.
2. Please remove your graphics card from your motherboard to insure the safest process and in order to prevent any possible damages to your CPU and motherboard.
3. It is strongly recommended to use market proven pre-mix coolant, such as Thermaltake Coolant 1000.

### Parts List

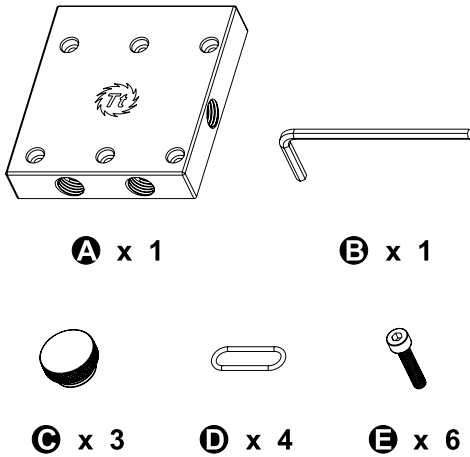

### Installation guide

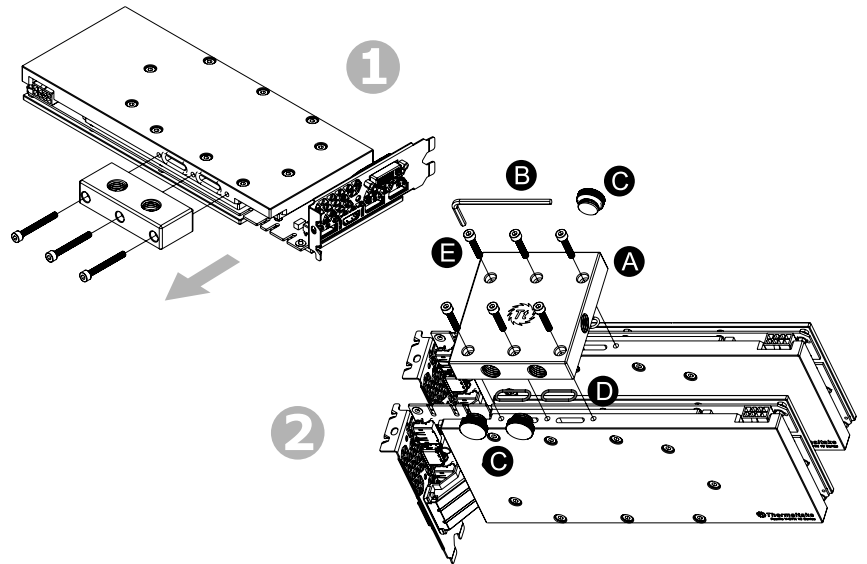

### Choosing inlet and outlet port

It is important to use the correct inlet and outlet configurations. By not using the correct ports may result in water bypassing the water blocks instead of flowing through the water blocks. This may cause damage and overheating issues.

- X** Inlet or outlet not possible please block
- Outlet and inlet both possible
- Outlet and inlet both possible
- Optional outlet or inlet both possible

Note :

1. Only one port must be used as inlet and one port as outlet
2. Ports can be exchanged, meaning inlet can be used as outlet and at the same time outlet can be used as an inlet.

